

**E-
Catalogue
2021**

AMBROGIO
R O B O T

THE ROBOTIC LAWNMOWER



E-Catalogue 2021



ambrogiorobot.com

Consultation Guide

**Green
Line**

**Pro
Line**

**Next
Line**

Discover the 2021 Range by navigating between the three Lines



Click here to see the details of each model



Click here to see photos and videos of each model

You can also browse through the other sections



accessories



technology



**ZCS
Special
Contents**



At any time you can return to the main menu by clicking on the hamburger button

GREENline



The **GREEN** line was designed to allow you to benefit from all the advantages offered by Ambrogio's simple and innovative technology. The four models of the line, all with brushless motors, ensure excellent cutting and nutrition of the turf, resulting in a greener, lusher, and healthier lawn in a completely eco-friendly way. The models are very compact for small gardens and have the ability to hand the most difficult slopes and up to 4 different areas.

Green Line



L60 ELITE



- 200 mq
- Slopes up to 50%
- Bluetooth Receiver+APP



L60 ELITE S+



- 400mq
- Slopes up to 50%
- Bluetooth Receiver+APP



L15 DELUXE



- 600 mq
- Manage up to 4 separate areas
- Bluetooth Receiver+APP



L32 DELUXE



- 800 mq
- Manage up to 4 separate areas
- Bluetooth Receiver+APP



L60 ELITE

GREENline



L60 ELITE

200 m²/sqm

 5 Ah litio-ioni - 5 Ah lithium-ion

Simple, no installation, designed for small green areas. The robot's ease of use also allows it to be put into service immediately and transported across multiple areas and different gardens.



New brushless motor, new motherboard and keyboard restyling



Lightweight and portable

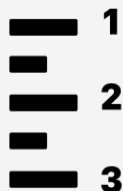

Slopes up to 50%



Four wheel drive



Eco Mode Sensor



Bluetooth Receiver



ZGS Sensor

GREENline



Charging Point



Keypad commands



Blade and ZGS Sensor



Bumper and obstacle sensor



Amico

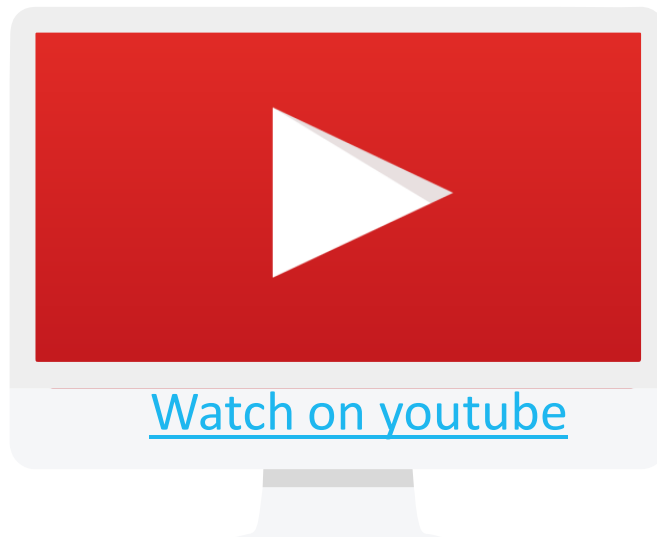

[Watch on youtube](#)

L60 ELITE S+

GREENline



L60 ELITE S+

400 m²/sqm

NEW

 7,5 Ah litio-ioni - 7,5 Ah lithium-ion

Simple, no installation, designed for small green areas. The robot's ease of use also allows it to be put into service immediately and transported across multiple areas and different gardens.



New brushless motor, new motherboard and keyboard restyling



Lightweight and portable

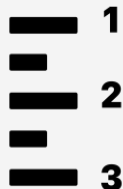

Slopes up to 50%



Four wheel drive



Eco Mode Sensor



Bluetooth Receiver

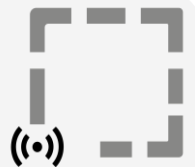

ZGS Sensor

GREENline



Charging Point



Keypad commands



Blade and ZGS Sensor



Bumper and obstacle sensor



Amico

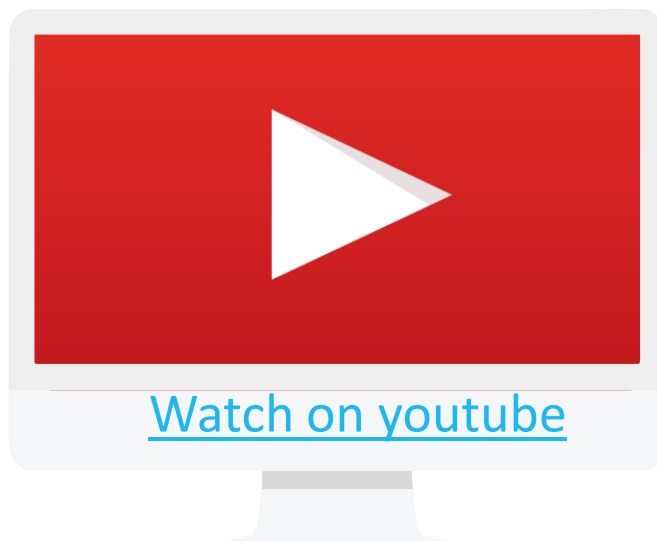

[Watch on youtube](#)

LIS DELUXE

GREENline



It is perfect for those who want a simple robot, without renouncing high technology locked up in only 42 cm and no more than 7 kg.



18 cm blade



High efficiency
brushless



Manage up to 4
separate areas



Keypad & LED



Eco Mode
Sensor



Bluetooth
Receiver

GREENline



Keypad commands



18 cm blade



Flex rubber rear wheels



Recharging base cover

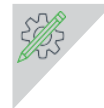

Amico

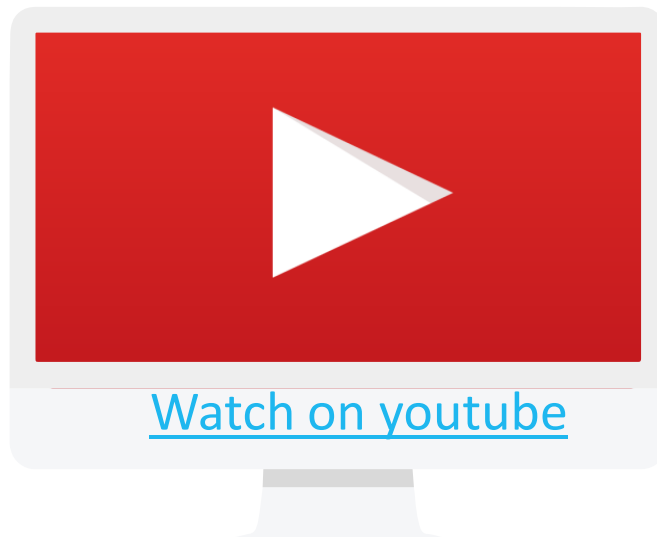

[Watch on youtube](#)

L372 DELUXE

GREENline



Created to cut small, but complex gardens with narrow and tight maneuvering spaces.



18 cm blade



High efficiency
brushless



Manage up to 4
separate areas



Keypad & LED



Eco Mode
Sensor



Bluetooth
Receiver

GREENline



Keypad & LED



4 point star blade



Spike wheel



Shelter garage shiny black



Shelter garage carbon look

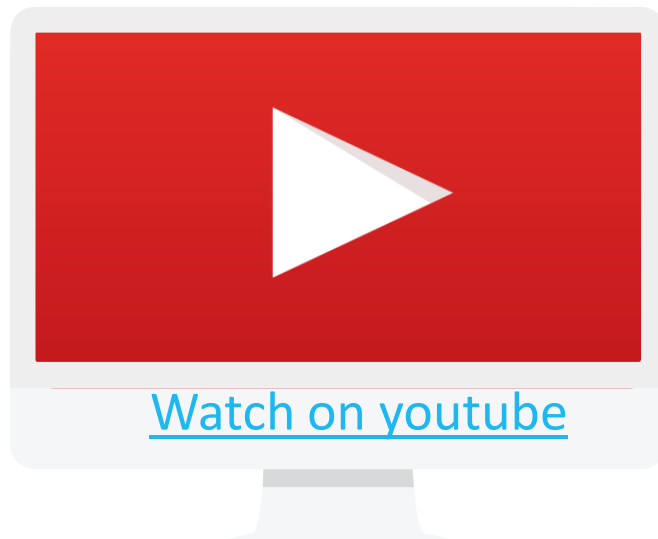

[Watch on youtube](#)



Enjoy a beautiful, well-tended lawn effortlessly and with the practicality of using the latest technologies. Get perfectly cut grass when and how you want it, manage the robot at all times and rely on efficient and user-friendly technology.

L35 B



- 1.200 mq
- Complex gardens, manage up to 8 separate areas
- Bluetooth Receiver + APP



L35 DELUXE



- 1.800 mq
- Complex gardens, manage up to 8 separate areas
- ZCS Connect



L250 DELUXE



- 2.600 mq
- Slopes up to 45%
- Complex gardens, manage up to 8 separate areas
- Bluetooth Receiver+APP





L250i ELITE



- 3.200 m²
- Slopes up to 45%
- Advanced Cutting systems
- ZCS Innovative inside +



L250i ELITE S+



- 5.000 m²
- Slopes up to 45%
- Advanced Cutting systems
- ZCS Innovative inside +



L350i ELITE



- 7.000 m²
- Slopes up to 45%
- Advanced Cutting systems
- ZCS Innovative Inside +



L400i



- 20.000 m²
- Slopes up to 45%
- Complex gardens, manage up to 8 separate areas
- ZCS Innovative Inside +



L35

PROline



L35 B

1.200 m²/sqm



5 Ah litio-ioni
5 Ah lithium-ion

2:30 h

Taglio consecutivo*
Continuous cutting*

18 h

Giardino libero
Free Garden Time

The two models from the L35 line include a high degree of innovation. The brushless motors, advanced cutting systems and the flex rubber wheel allow the robot to mow and maintain complex areas up to 1,200 sqm.



Flex rubber rear wheel



High efficiency brushless motors

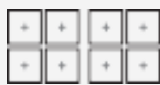

Manage up to 8 separate areas



ZCS Connect



SDM Cutting System



Bluetooth Receiver

PROline



Keypad & Led

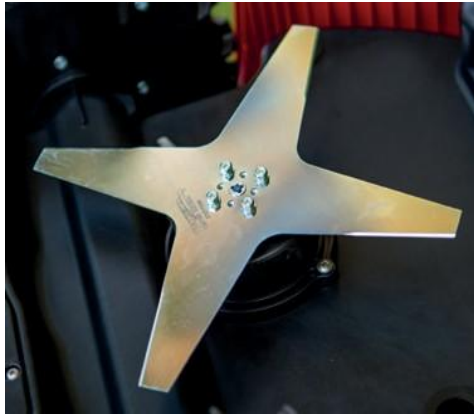

4 point star blade



Spike wheel



Recharging base cover



Shelter garage carbon look

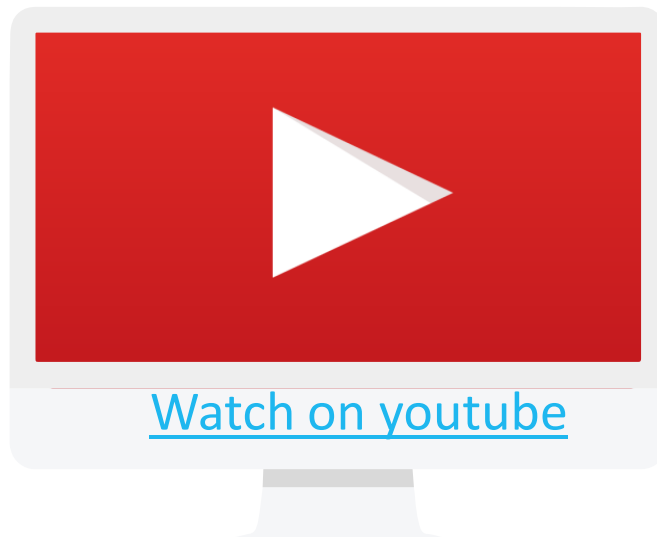

[Watch on youtube](#)

L35

PROline



L35 DELUXE

1.800 m²/sqm



5 Ah litio-ioni
5 Ah lithium-ion

2:30 h

Taglio consecutivo*
Continuous cutting*

17 h

Giardino libero
Free Garden Time

The two models from the L35 line include a high degree of innovation. The brushless motors, advanced cutting systems and the flex rubber wheel allow the robot to mow and maintain complex areas up to 1,800 sqm.



Flex rubber rear wheel



High efficiency brushless motors



Manage up to 8 separate areas



ZCS Connect



SDM Cutting System



Bluetooth Receiver

L35 DELUXE



PRO



Keypad & Led

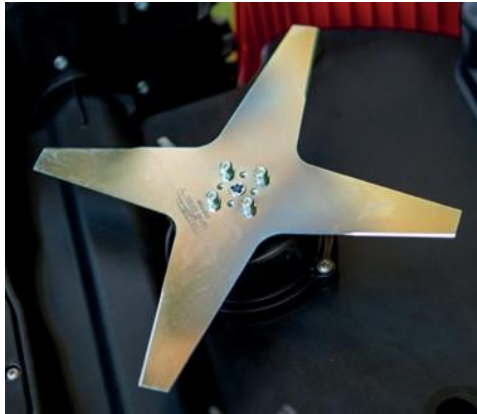

4 point star blade



Spike wheel



Recharging base cover



Shelter garage carbon look

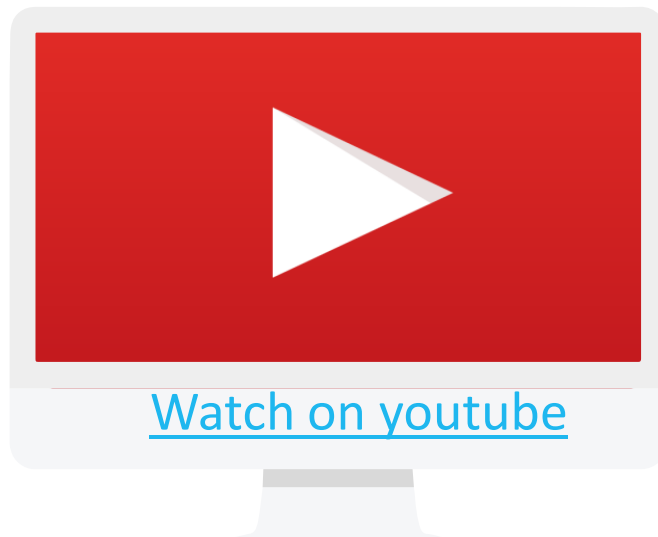

[Watch on youtube](#)

L250 DELUXE

PROfile



The model is ideal for those who want a robust, high-performance and innovative robot. The user interface with large, standard touchscreen display makes handling the robot simple and intuitive.



High efficiency brushless motors



Manage up to 8 separate areas



Slopes up to 45%



7.5 Ah lithium-ion battery



Eco Mode Sensor



Bluetooth Receiver



Patented front wheels

L250 DELUXE



PROline



Touchscreen Display



4 point star blade



Flex rubber rear wheel

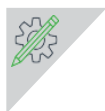

Spike wheel



Shelter garage shiny black

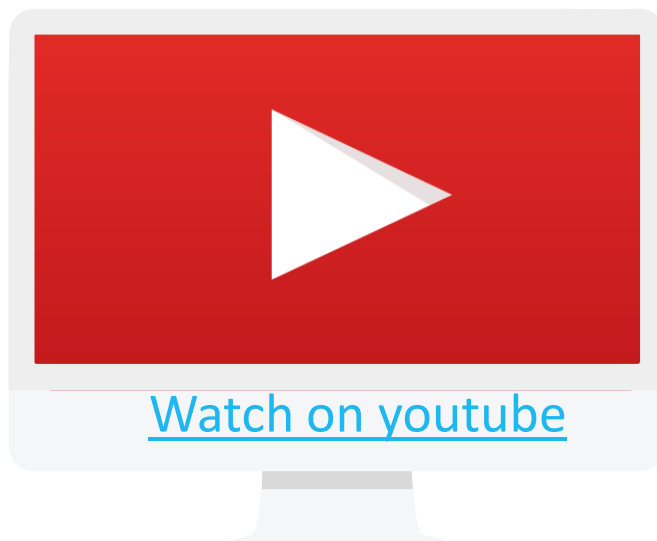

[Watch on youtube](#)

L250i

PROline



L250i ELITE

3.200 m²/sqm



7,5 Ah litio-ioni
7,5 Ah lithium-ion

3:30h

Taglio consecutivo*
Continuous cutting*

16h

Giardino libero
Free Garden Time



INNOVATIVE
MOTHERBOARD



TOUCH
DISPLAY



BLUETOOTH &
GSM



ZCS
CONNECT



SMART
ASSISTANT

The two models are a concentration of innovation and technology. The touchscreen display, the advanced navigation systems and standard ZCS Connect module make the robots extremely performing.



Flex rubber rear
wheel



High efficiency
brushless
motors



Manage up to 8
separate areas



Slopes up to 45



SDM Cutting
System



Patented Front
Wheels

PROline



Touchscreen Display



4 point star blade



Flex rubber rear wheel



Spike wheel



Shelter garage shiny black

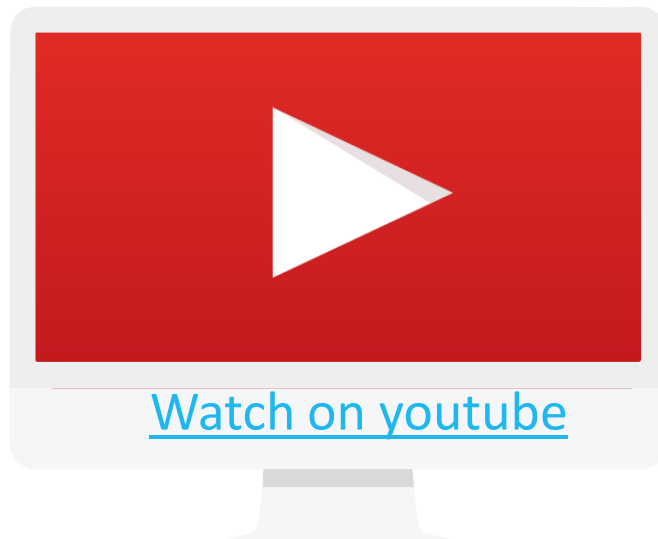

[Watch on youtube](#)

L250i

PROline



L250i ELITE S+

5.000 m²/sqm



7,5 Ah litio-ioni
7,5 Ah lithium-ion

7:00h

Taglio consecutivo*
Continuous cutting*

12h

Giardino libero
Free Garden Time



INNOVATIVE
MOTHERBOARD



TOUCH
DISPLAY



BLUETOOTH &
GSM



ZCS
CONNECT



SMART
ASSISTANT

The two models are a concentration of innovation and technology. The touchscreen display, the advanced navigation systems and standard ZCS Connect module make the robots extremely performing.



Flex rubber rear
wheel



High efficiency
brushless
motors



Manage up to 8
separate areas



Slopes up to 45



SDM Cutting
System



Patented Front
Wheels

L250i ELITE S+



PROline



Touchscreen Display



4 point star blade



4 point star blade



Spike wheel



Shelter garage shiny black

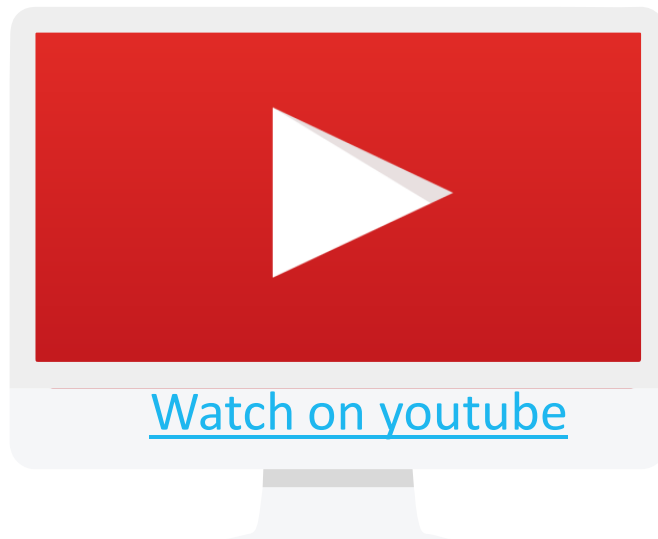

[Watch on youtube](#)

L350i ELITE

PROline

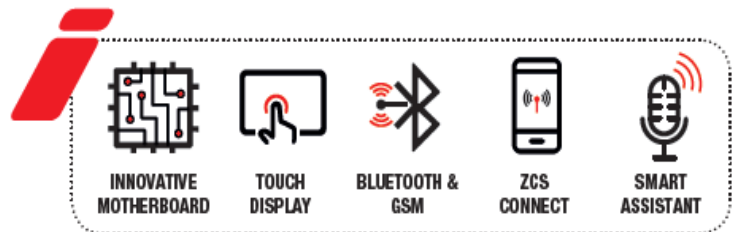

It can work for seven consecutive hours, while maintaining high mowing performance. The touchscreen display makes programming simple and intuitive



15 Ah litio-ioni
15 Ah lithium-ion

7:00 h

Taglio consecutivo*
Continuous cutting*

9 h

Giardino libero
Free Garden Time



Flex rear wheel



High efficiency
brushless
motors



Manage up to 8
separate areas



Slopes up to 45



SDM Cutting
System



Powerful lithium-
ion batteries

PROline



Touchscreen Display



4 point star blade



Flex Rubber wheel



Spike wheel



Shelter garage shiny black

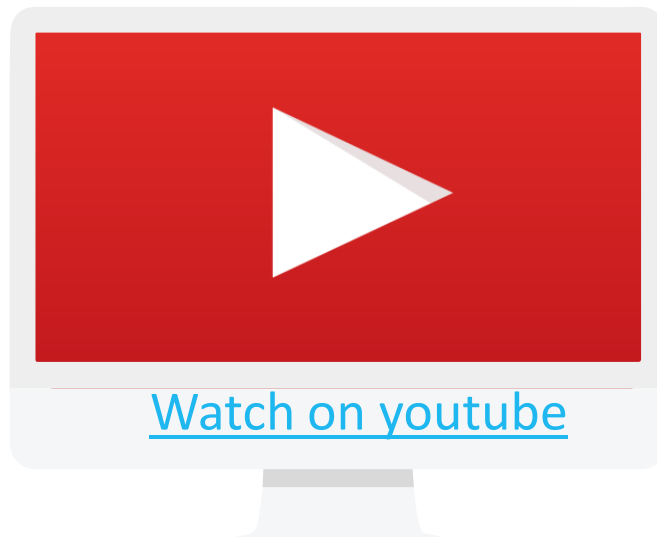

[Watch on youtube](#)

L400i

PROline



L400i B
10.000 m²/sqm

L400i DELUXE
20.000 m²/sqm

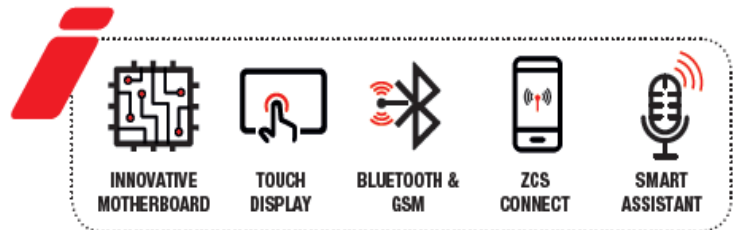

A powerful robot with an attractive design typical of Italian products, which can manage gardens up to 20,000 sqm. The two models are also equipped with the ZCS Connect, to connect and interact with the robot any time and anywhere



High efficiency brushless motors



Manage up to 8 separate areas



Slopes up to 45%



Powerful lithium-ion batteries



Blade motorization



Perfect cut even on uneven ground



Flex rubber rear wheel



SDM Cutting System

PROline



*Touchscreen
Display*



*4 point star
blade*



*Flex rubber
wheel*

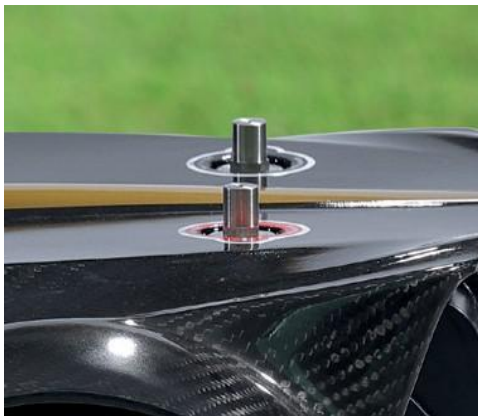

Charging points

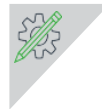

Amico

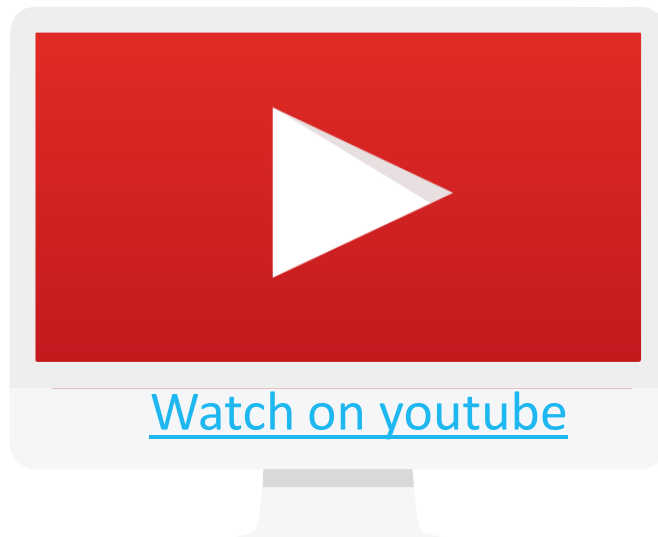

[Watch on youtube](#)

NEXT line



The revolutionary NEXT line was born in the era of digital technology, of Internet of Things, Cloud and connectivity, but also of the customisation and flexibility of smart products.



TWENTY



- 1.300 mq
- Innovative cutting systems
- ZCS Connect*

*some models



4.0 basic



- 2.200 mq
- Perfect management of uneven terrains up to 4 separate areas
- Bluetooth Receiver+APP



4.0 elite



- 3.500 mq
- Perfect management of uneven terrains up to 8 separate areas
- ZCS Connect



4.36 elite



- 6.000 mq
- Perfect management of uneven terrains up to 8 separate areas
- ZCS Connect



TWENTY

NEXTline



TWENTY deluxe

700 m²/sqm

TWENTY elite

1.000 m²/sqm

TWENTY elite s+

1.300 m²/sqm

NEW

A mini robotic lawnmower equipped with the most advanced features. The latest generation processors, brushless motors, powerful batteries and 18 cm blade allow the robot to manage up to 4 separate areas.



Smart Assistant
(Elite and Elite S+)



Next generation
processors



Bluetooth & GSM



ZCS Connect



Keypad & LED

TWENTY deluxe



NEXTline



Keypad
command

S



18 cm blade



Flex rubber
rear wheels



Shelter garage shiny
black

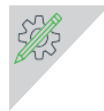

Amico

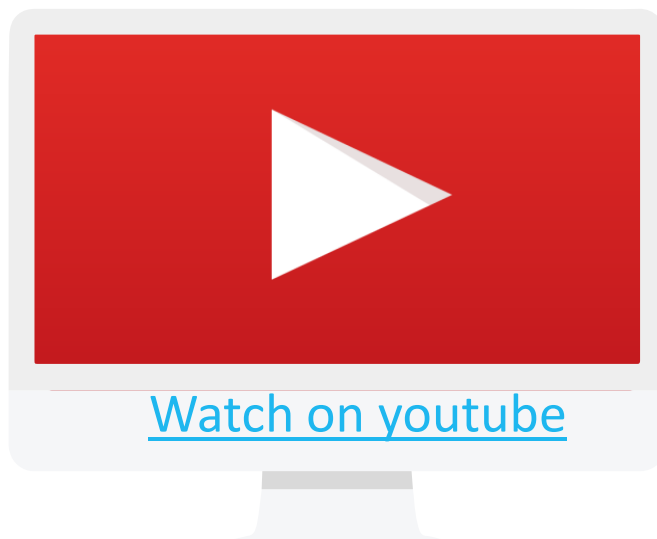

[Watch on youtube](#)

4.0 basic

NEXTline



A simple and reliable robot that can adapt to changes. Its flexible yet solid and safe structure enables the installation of three different types of Power Units, to manage areas from 1,000 sqm to 2,200 sqm.



Next generation processors



App Bluetooth



SMART
batteries



Rubber wheels



Keypad & LED



Jointed



ZGS Self-cleaning

4.0 basic



NEXTline



*Keypad &
LED*



25 cm blade



*Double tyred
rubber wheel*

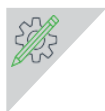

Spike wheel



*Shelter garage
shiny black*

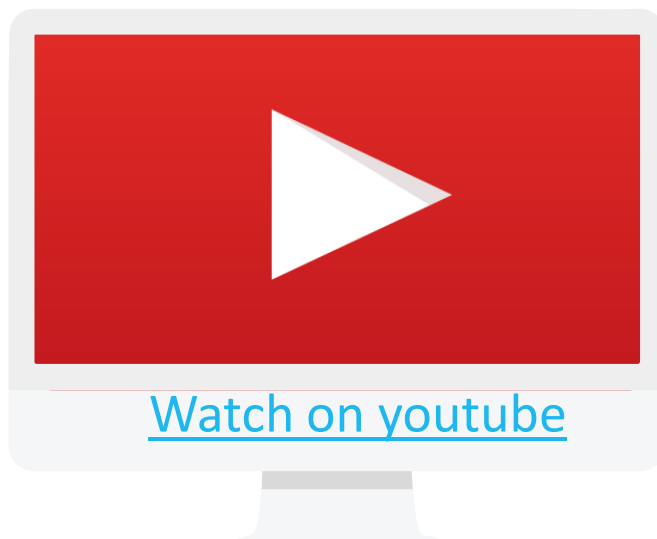

[Watch on youtube](#)



The robot combines the characteristics of flexibility and modularity with 4.0 technological innovation. It can be combined with the Medium, Premium and Extra Premium Power Units ranging between 2,200 sqm and 3,500 sqm. The Extra Premium kit makes it possible to equip the robot with the inductive recharge device.



Smart Assistant



Next generation processors



Bluetooth & GSM



ZCS Connect



Smart batteries



Blade motorisation



Jointed



Self-cleaning



Rubber wheels



Touch Display



SDM Cutting System

4.0 elite



NEXTline



Touchscreen display

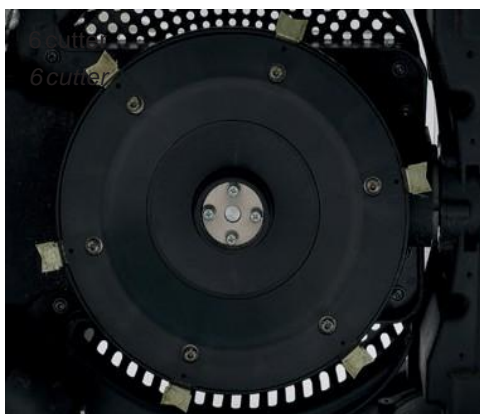

6 cutter



Inductive charging

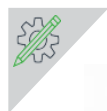

Spike Wheel



Shelter garage shiny black

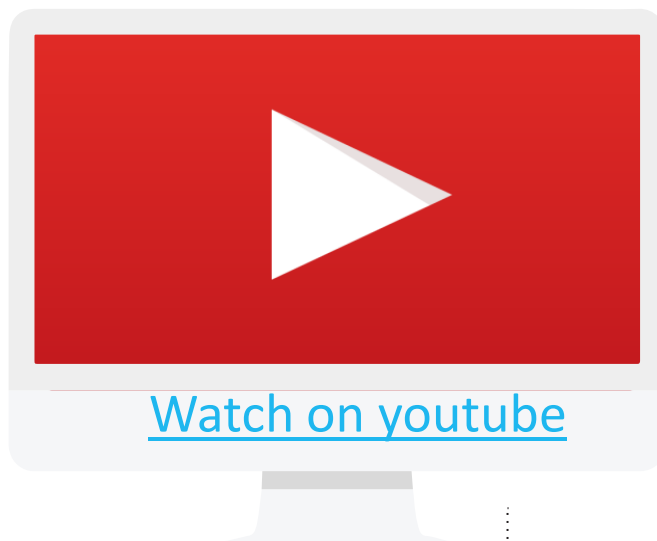

[Watch on youtube](#)



4.36 elite

NEXTline



The powerful battery and the 36 cm blade of Ambrogio 4.36 Elite model allow it to handle large areas. With the Ultra Premium Power Unit, the robot is able to work for over 4 hours.



Smart Assistant



Next generation processors



Bluetooth & GSM



ZCS Connect



Smart batteries



Blade motorisation



Jointed



Self-cleaning



Rubber wheels



Touch Display



SDM Cutting System

4.36 elite



NEXTline



Touchscreen display

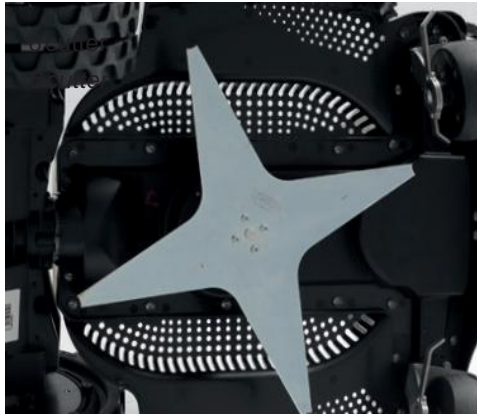

4 point star blade



Triple rubber wheel



Spike Wheel



Shelter garage shiny black

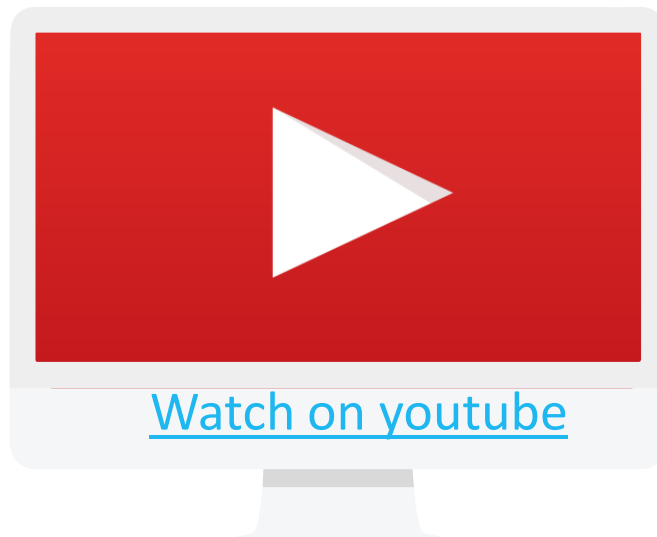

[Watch on youtube](#)

Accessories



[Installation KIT](#)

[Recharging
Base Cover](#)

[Spikes](#)

[AMICO](#)

AMBROGIO
R O B O T

THE ROBOTIC LAWNMOWER



Installation Kit

<i>Installation Kit SS</i>	<i>150m wire</i>	<i>300 pegs</i>	<i>3 connectors</i>
<i>Installation Kit S</i>	<i>150m wire</i>	<i>300 pegs</i>	<i>3 connectors</i>
<i>Installation Kit L</i>	<i>300m wire</i>	<i>500 pegs</i>	<i>6 connectors</i>

Recharging base cover



*Shelter Garage colour
shiny black*

L15 DELUXE
TWENTY



*Shelter Garage colour
black carbon look*

L32
L35



*Shelter Garage colour
shiny black*

L32
L35



*Shelter Garage colour
shiny black*

L250
L250i



*Shelter Garage colour
shiny black*

L350i ELITE



*Shelter Garage colour
shiny black*

4.0
4.36 elite



Spikes



L32
L35



L250
L250i
L350i ELITE

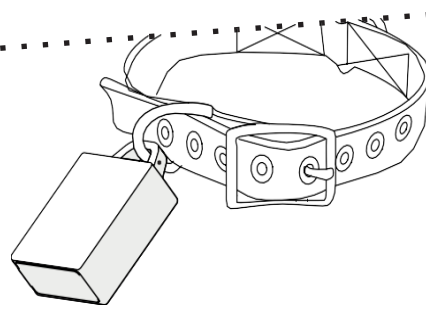

4.0
4.36 elite

The logo for AMICO, featuring the word "AMICO" in a bold, black, sans-serif font. The letter "O" is stylized with a heart shape inside it. The logo is set against a green rectangular background with rounded corners.

Ambrogio is a friend to all animals and respects their need for space.

AMICO is the new technology bearing the ZCS logo that ensures the safe operation of Ambrogio robot near animals wearing an AMICO, until the automatic shutdown of the blade. A micro device to be put on an average/large-sized pets's collar, or on its back, as in the case of a tortoise. The AMICO tag communicates with Ambrogio robot as it approaches any animal with the tag.

AMICO is harmless and safe.

Technology



AmbrogioRemote APP

Infinity
System

Voice
Control

AMBROGIO
R O B O T

THE ROBOTIC LAWNMOWER

Ambrogio Remote APP

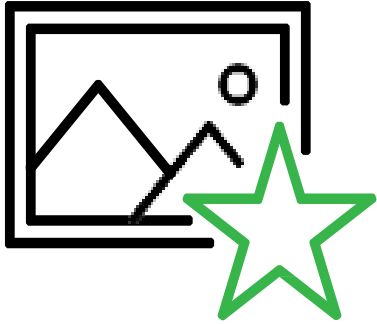

Graphic restyling



Manual robot control via Bluetooth

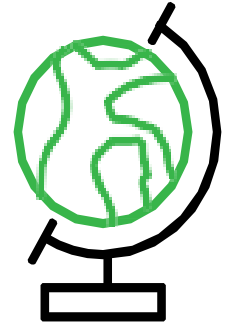

Download manuals

With the ZCS CONNECT MODULE* the future is here and now!

Geographic localisation

The robot is localised on the map

Geofence alarm

An evolved anti-theft device

Go away

Temporarily exclude a particular area of the garden

Go Home

To send the robot to recharging base

***The functions available for the L60 model are:
Remote monitoring of the robot status |
Receive notifications in case of error |
Receiving Geofence notifications | Stop the robot***

Infinity System



+INFINITYSYSTEM, through the Cloud technologies and ZCS Connect, creates a constantly shared virtual map on the area to be mowed. The shared map allows robots to know the already cut micro areas optimising the working time, without neglecting any area and with maximum precision. The robots equipped with **+INFINITYSYSTEM** have the ability to readjust themselves to work in areas that have increased their surface over time. External areas which become "yards" can be managed in a perfect combination with all the other green spaces.

The **+ INFINITYSYSTEM** system is recommended for the maintenance of medium/large spaces up to very large areas such as sport fields, airfields and gol courses.

Voice Control

Ambrogio robot speaks the language of the future!

The models equipped with ZCS Connect are able to communicate with the most popular voice assistants (Apple's Siri, Google Home and Amazon's Alexa). The function allows you to control the robot with simple voice commands, without using an APP or a display, but remotely, via a simple internet connection.



Champions & Friends



Let's meet all our popular friends who have chosen to share their experience with Ambrogio

Ambrogio's
Champions

Ambrogio's
Friends

Champions



Maurizia
Cacciatori



Franck
Reporter



Mike
Odelli



Cantine Ferrari

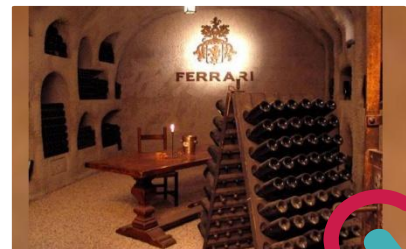

Friends



Silvano Galdenzi

Giampaolo Bui

Vasco Canepari

Maria Angela Modugno

Carolina Pallavicino

Davide Cardano

Marco Porcella

Claudio Novello

Gianfranco Sola

Gian Mario Merli

Stefania Bessolo Veneria

Roberto Memeo

Fiorenzo Lusso

Leonardo Nappi

Annarita Ciccione

Cristian Noli

Marina Fassone



Maurizia Cacciatori

Maurizia Cacciatori (Carrara, April 6, 1973) is a former Italian volleyball player, and a TV speaker for Sky Sports of Women's Volleyball matches



La Spezia
[Twenty Elite](#)

Enthusiasm, resilience, team spirit, and the ability of cooperating have allowed me to win: and these are all key values Ambrogio Robot's history

See also



@mauriziacacciatori



@ambrogiorobot



Maurizia Cacciatori



Franck Reporter

“Stock photographer based in Tuscany (Italy), the web knows me as “franckreporter”. My home is a suitcase, I gotta love traveling and sharing my experiences gained around the world”



franckreporter • Segui già
Toscana, Italy



franckreporter Già da tempo tramite le mie stories lo avete conosciuto. Lui è Ambrogio, 🚗 il mio maggiordomo del giardino (quello che mi taglia l'erba e mi fa riposare.. pensa a tutto lui) . Me lo stanno facendo provare i ragazzi di @ambrogiorobot . Prima avevevo sempre un Ambrogio, il nonno di questo :), devo dire che in questi anni sono stati fatti enormi passi avanti dalla tecnologia e lui ne è la prova. #AmbrogioRobot #lawnmower #lawncare #lawnmowing

15 h



angfaw9 Ottimo!



11 h Rispondi



Piace a alloyandgrit e altri 656

15 ORE FA

You have known him for some time through my stories. He is Ambrogio, my garden steward (the one who cuts the grass and makes me rest .. he takes care of everything). The guys from @ambrogiorobot are letting me try it. Before, I used to own an older version of this one, I must say that in recent years enormous progress has been made in technology and Ambrogio is proof of this.

See also



@franckreporter



Mike Odelli

YouTuber, digital content creator, but above all eclectic storyteller



Some might say that I spoil myself with toys. NO! On the contrary, I am happy with small things. For example with a lawnmower. A lawn mower that works on its own and looks like a tank.. Welcome, Pippo!

And thanks to @ambrogiorobot for the birthday present!
#giftedby #ambrogiorobot

Do you have "non-living" friends?
#special friends #artificialintelligence #robot #mower #toys #ideeperlacasab

See also



@ambrogiorobot



@Just Mick



Cantine Ferrari

A Winery that was founded in 1902, which produces Sparkling Wine - Classic Method for both the Italian and international markets.



Trento
[4.0 Elite](#)

A bottle of Ferrari and Ambrogio Robot. Two Made in Italy brands that are used by all those families that love high quality products which express excellence

See also



Ambrogio Robot



Silvano Galdenzi



Ancona



7.000 mq

L350i + L250i

The shredding of the grass that Ambrogio releases on the ground makes the turf much more resistant to drought

Giampaolo Bui

Novara



500 mq

L85 Deluxe

Thanks to Ambrogio, throwing heavy bags of cut grass away in the trash is an old memory.





Vasco Canepari



Reggio Emilia

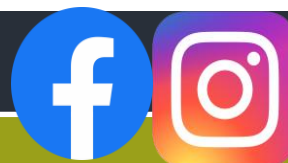

7.000 mq

N.2 L250i Elite S+

After many years, I decided to have a little more time for myself, so I gave myself a gift: Ambrogio

Maria Angela Modugno

Savona



1.500 mq

4.0 Elite

Look how beautiful my lawn is, thanks to me and with the help of my friend Ambrogio





Carolina Pallavicino



Cuneo

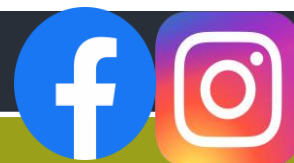

4.000 mq

L35 Deluxe + L250i Elite

What to say? Ambrogio is better than a gardener! I don't have to think about cutting the garden anymore

Davide Cardano

Torino



595 mq

L35 Deluxe

We are very satisfied with the results.

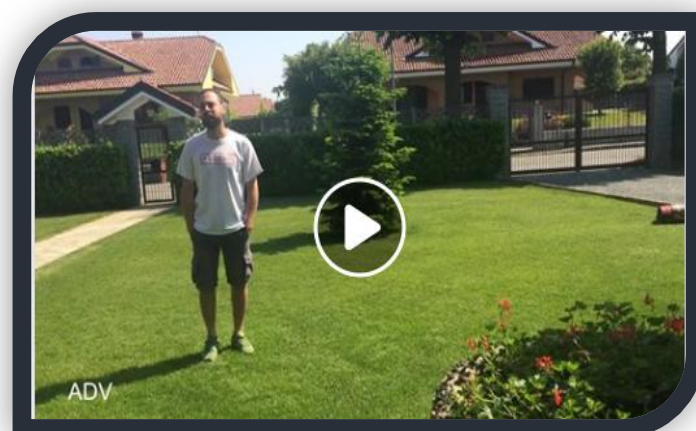



Marco Porcella



Savona



1.000 mq

4.0 Basic

Ambrogio, fast and cheap.
Thanks to him I no longer have
the problem of maintaining the
lawn

Claudio Novello

Forlì Cesena



400 mq

4.0 Basic

The robot always keeps the
grass well cut and this allows
you only intervene to smooth
the details (edges) and always
keep the lawn tidy

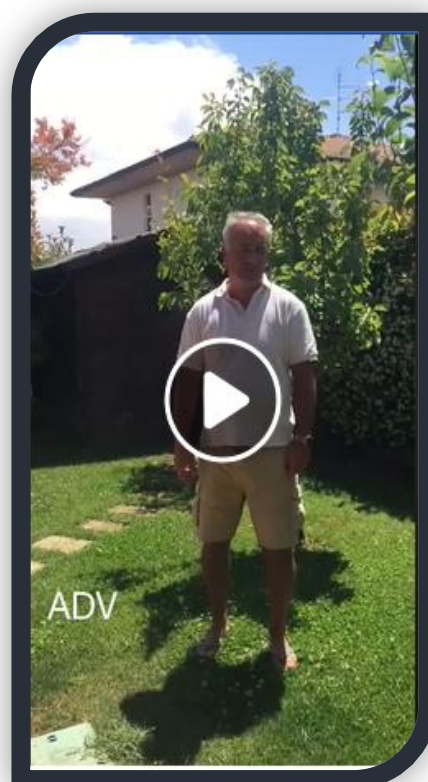



Gianfranco Sola

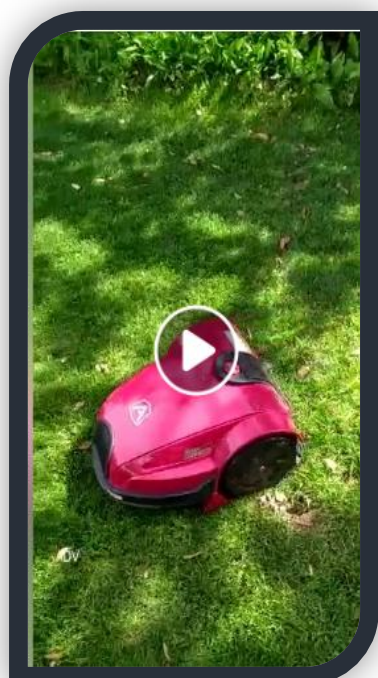

Savona



1.000 mq

L30 Elite

It works really well. I recommend it to all those people who have a lawn to manage and who do not want to cut the grass by hand

Gian Mario Merli

Piacenza



300 mq

L30 Elite

It mows for three hours every day so that the lawn is always beautiful

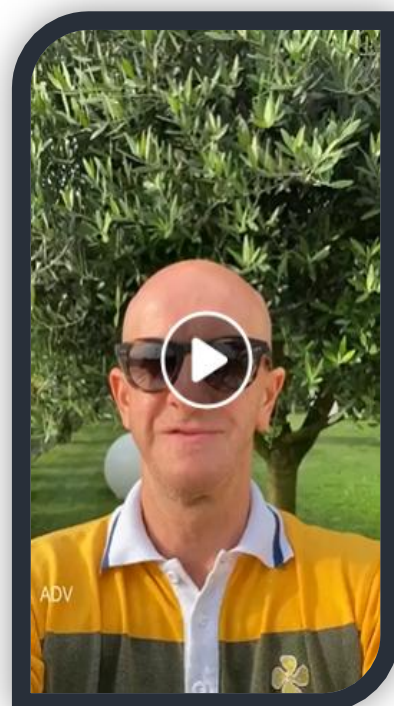



Stefania Bessolo Veneria



Torino

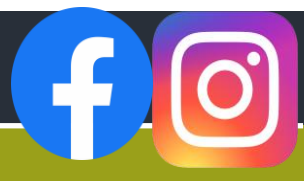

4.0 Elite

Thanks to Ambrogio we went back to enjoy our precious time at home

Roberto Memeo

Ancona

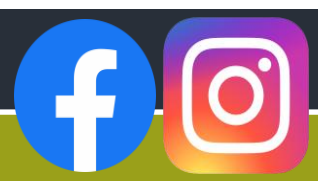

7.000 mq

L350i + L250i

As you can see, the lawn is green, without the use of any chemical fertilizer. It is all natural thanks to the mulching cut of Ambrogio





Fiorenzo Lusso

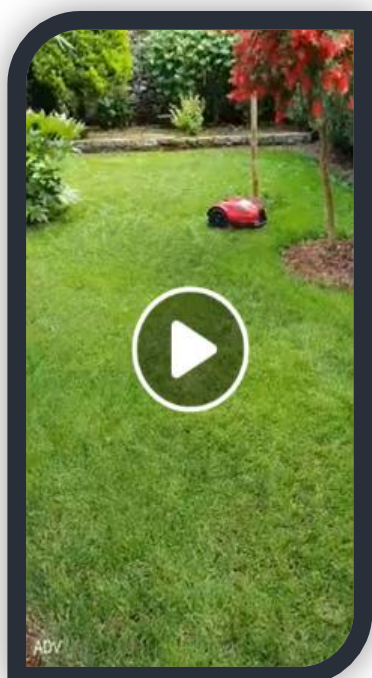

Savona



60 mq

L30 Deluxe

A fantastic accessory for our lawn, to always keep it in perfect shape.

Leonardo Nappi

Savona



500 mq

L60 Elite

it cuts the grass well, finely and, above all it makes the lawn look better.





Anna Rita Ciccone



Savona



150 mq

L60 Elite

It was easy and intuitive from the very first use, no problems and no installation

Cristian Noli

Lodi



360 mq

L30 Elite

Cut the grass from the balcony!





Marina Fassone



Genova



350 mq

Twenty Deluxe

With a tireless and precise Ambrogio Robot, the lawn is always perfectly mowed